

TABELA DE ÁREAS

Nº	IDENTIFICAÇÃO	ÁREA
01	ESTACIONAMENTO 01	1719,70 m ²
02	BLOCO ADMINISTRATIVO	3087,20 m ²
03	ÁREA PISCINA	991,00 m ²
04	LANCHONETE/SALINAS	72,80 m ²
05	VESTIÁRIOS	96,80 m ²
06	CIRCULAÇÃO	1013,50 m ²
07	ÁREA DE ARQUIBANCADAS	1245,60 m ²
08	ÁREA PISCINA SEMI-OLÍMPICA	1051,40 m ²
09	CIRCULAÇÃO	282,70 m ²
10	QUADRA POLIESPORTIVA	1390,90 m ²
11	ESTACIONAMENTO 02	2190,00 m ²



PROJEÇÃO DO SOL
ESC.: 1:2500



VENTOS PREDOMINANTES
ESC.: 1:2500



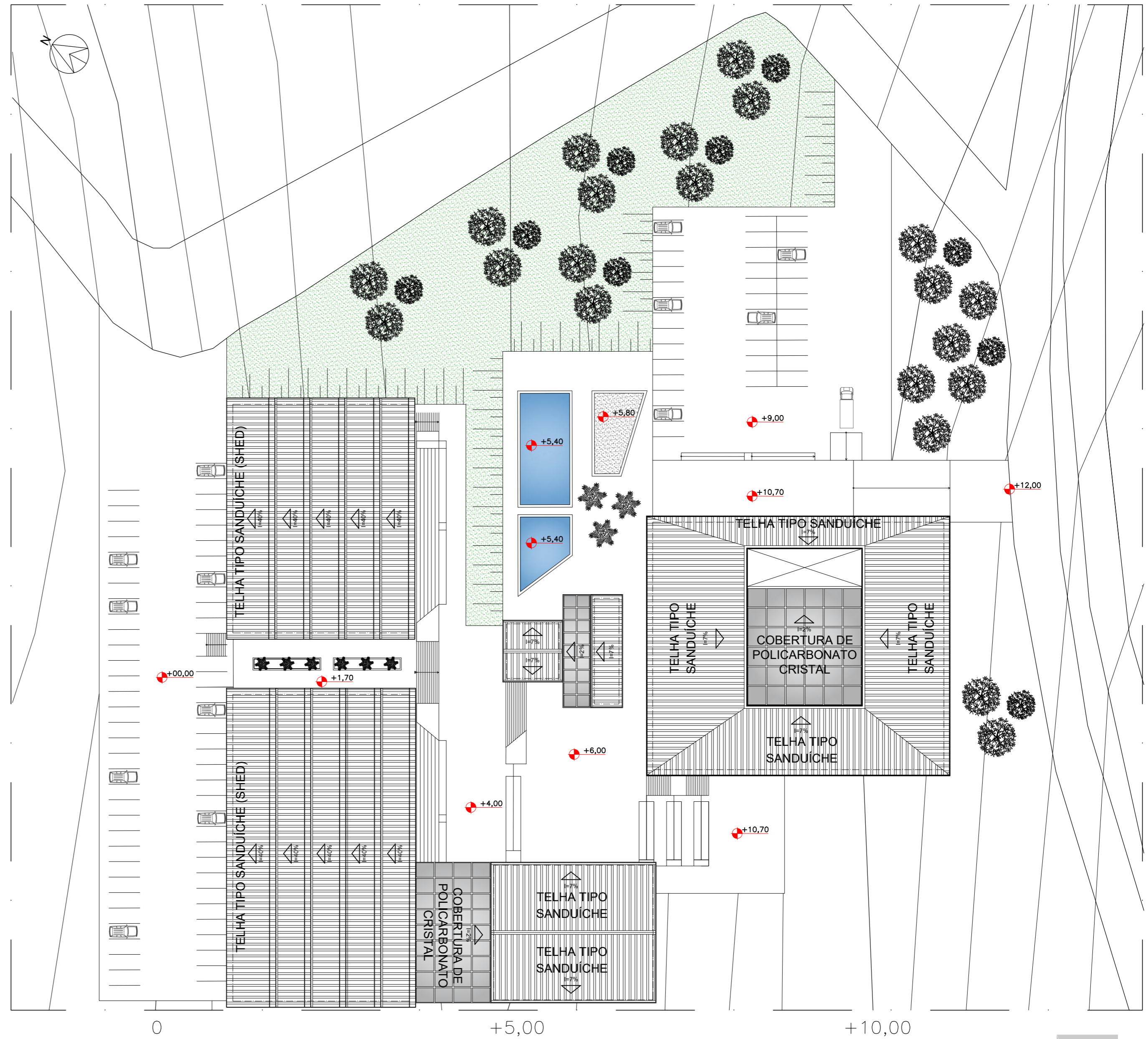

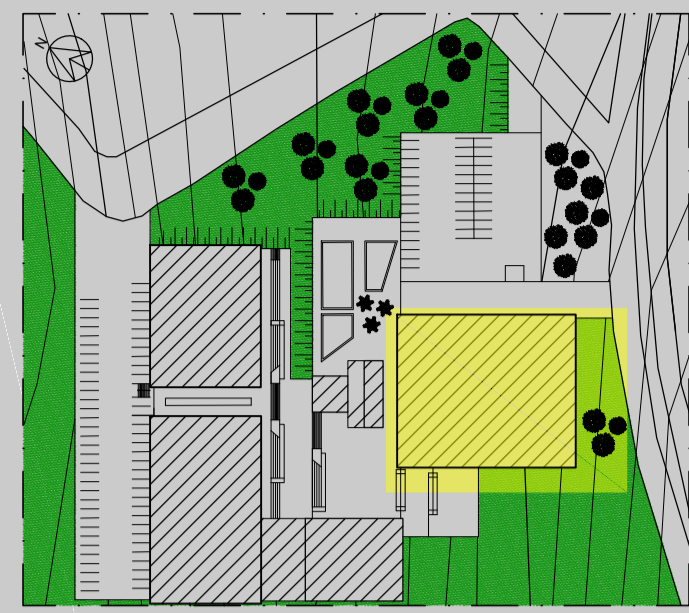

PLANTA CHAVE
ESCALA 1:1000



PERSPECTIVA ENTRADA



PERSPECTIVA ESTACIONAMENTO

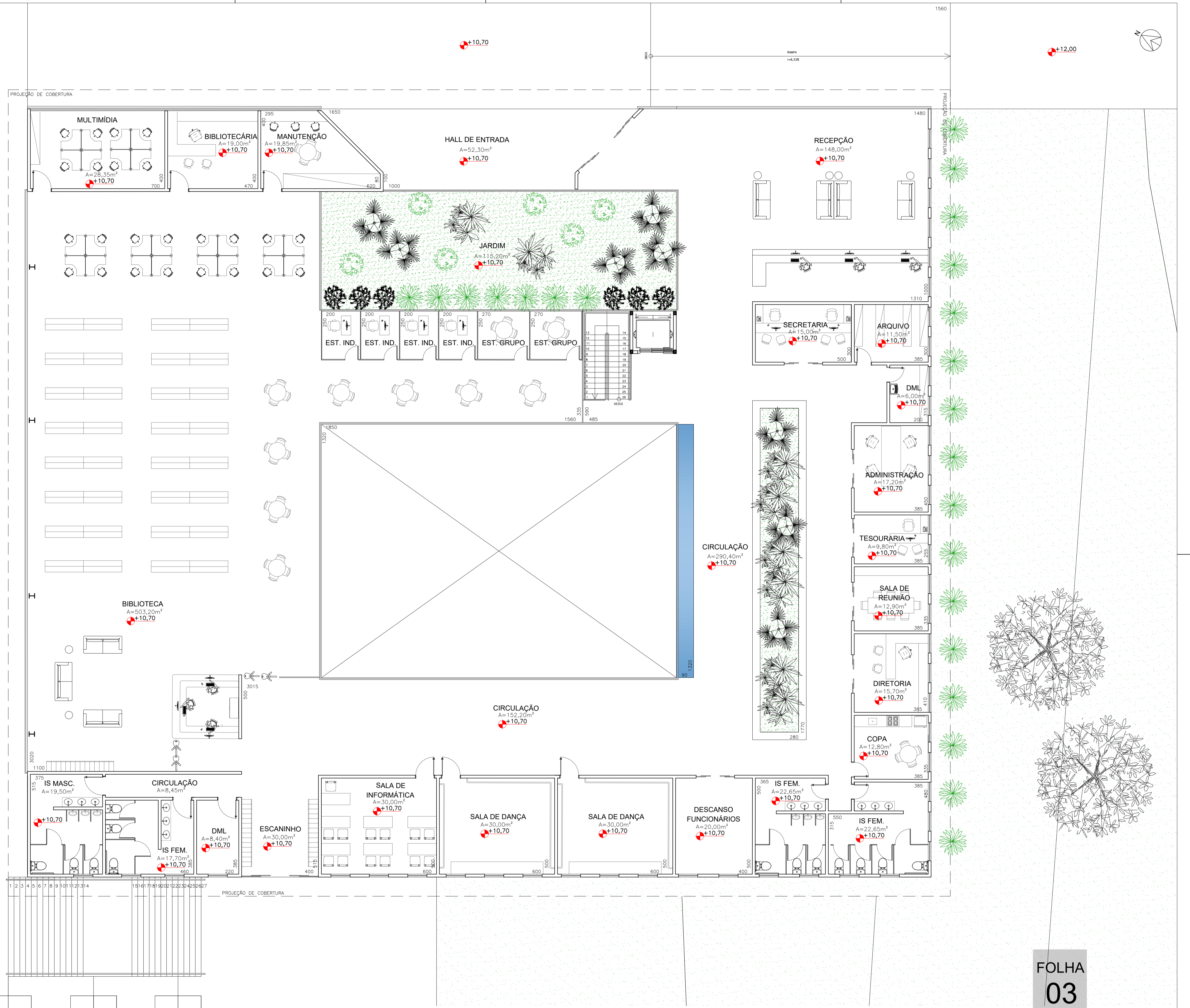

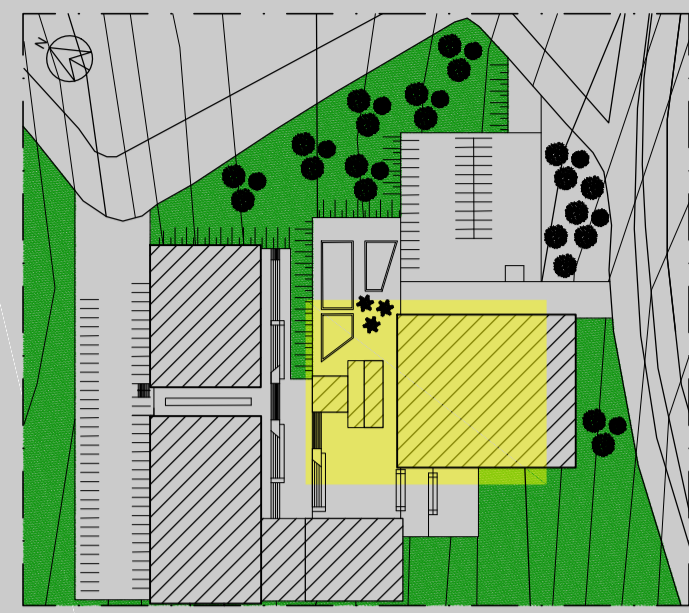

PLANTA CHAVE
ESCALA 1:1000

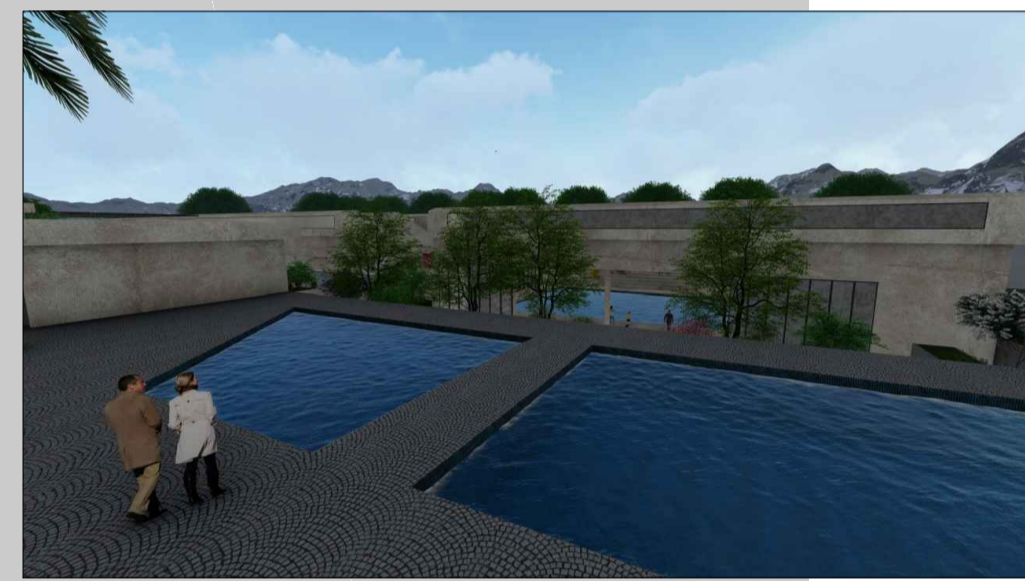

PERSPECTIVA PISCINAS

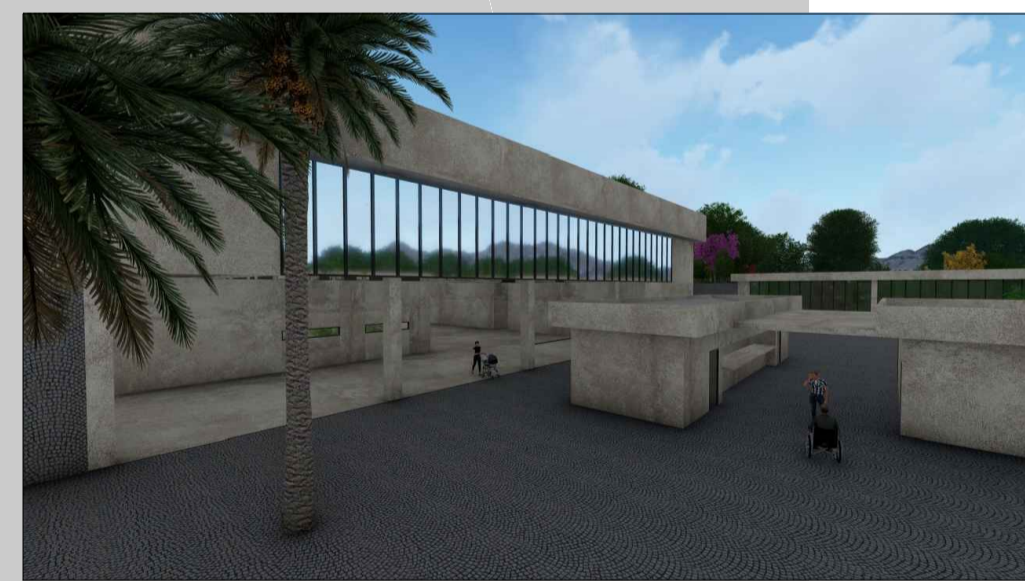

PERSPECTIVA LANCHONETE

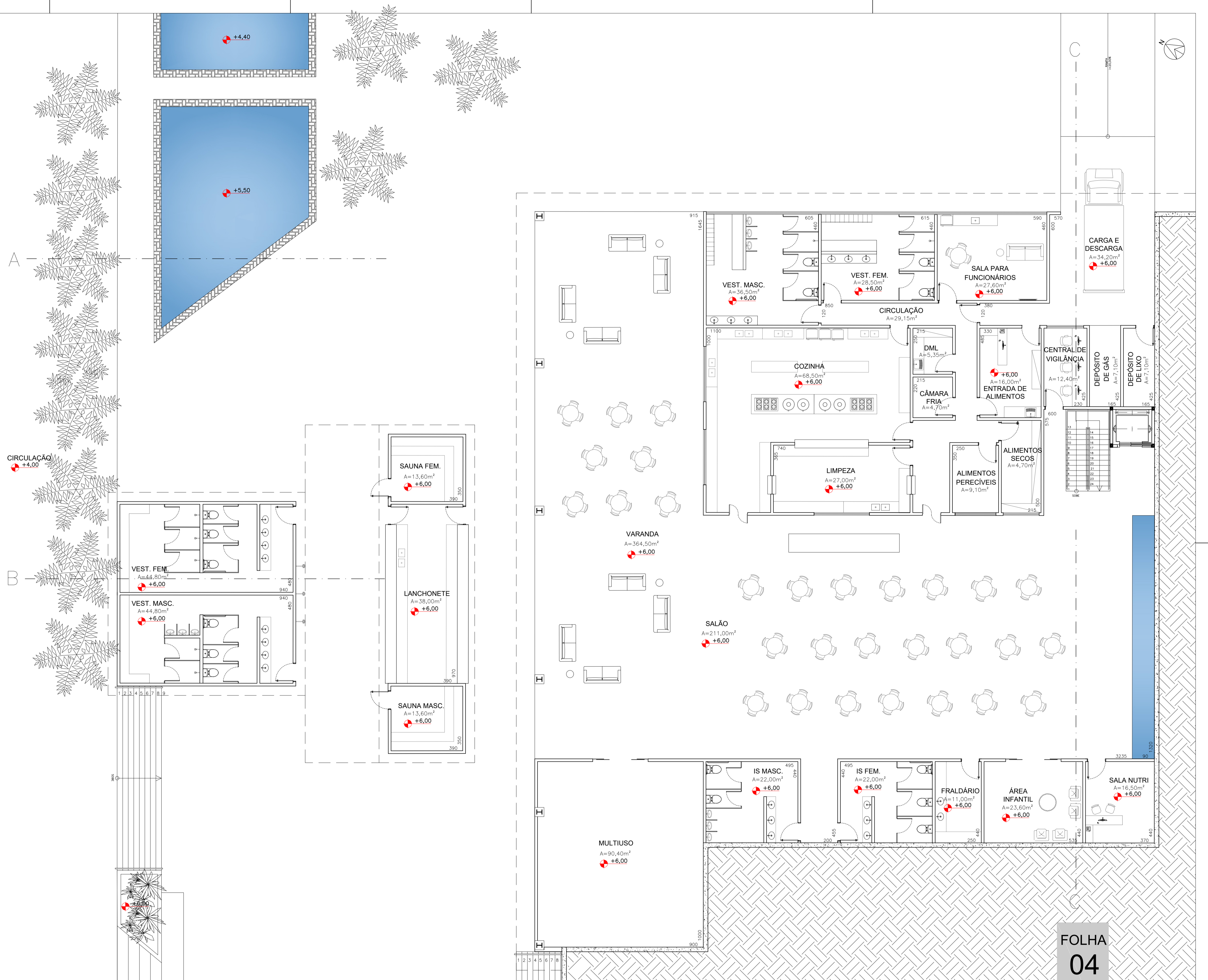

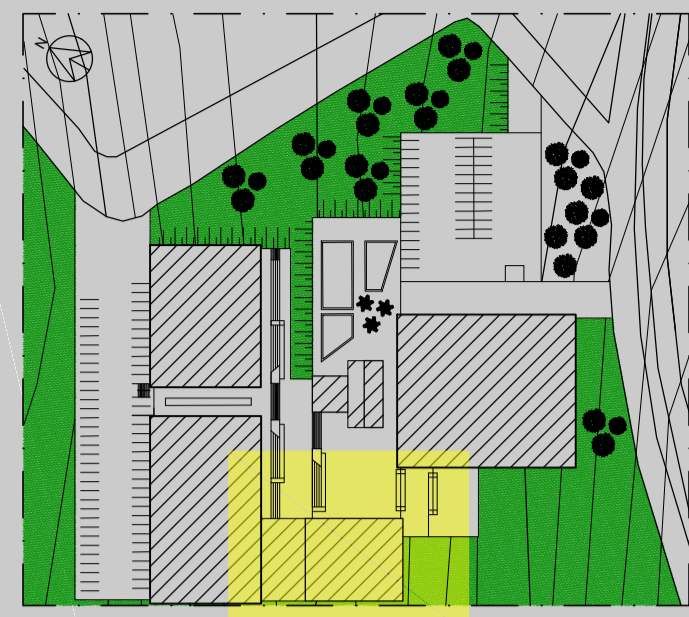

PLANTA CHAVE
ESCALA 1:1000



PERSPECTIVA CIRCULAÇÃO



PERSPECTIVA QUADRA

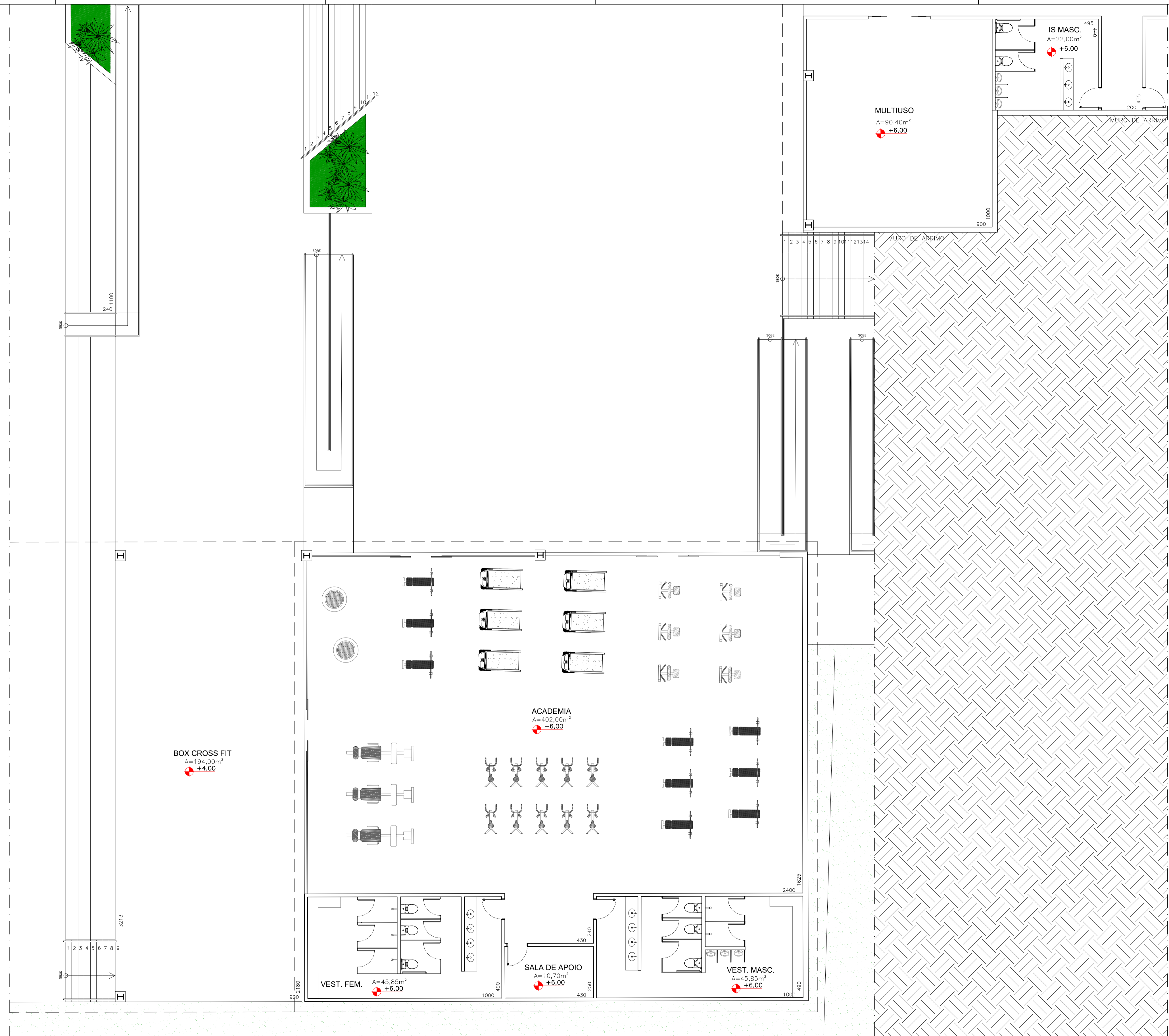



PLANTA CHAVE
ESCALA 1:1000

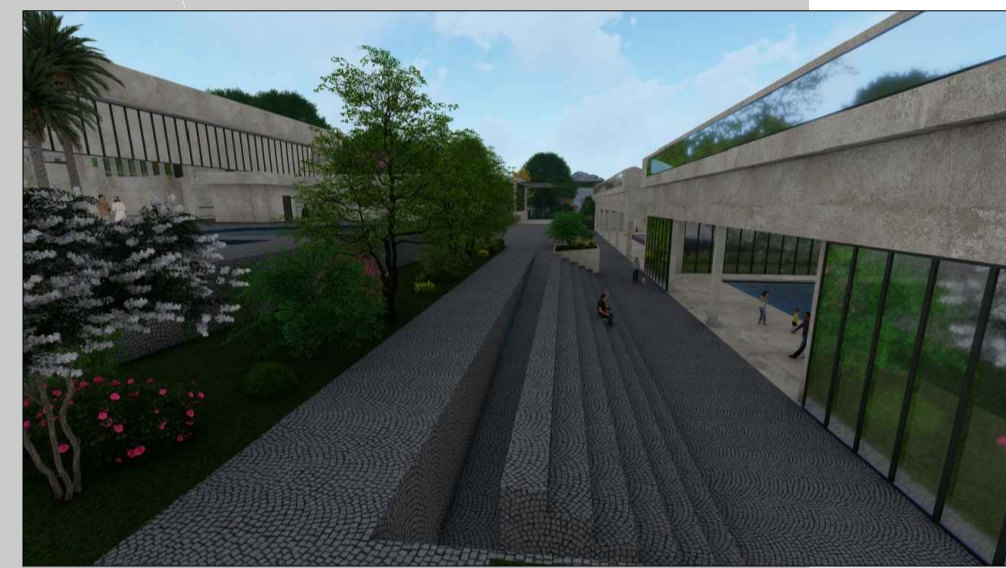

PERSPECTIVA CIRCULAÇÃO



PERSPECTIVA PISCINA SEMI-OLÍMPICA

ESTACIONAMENTO
A=2190,00m²
+0,00

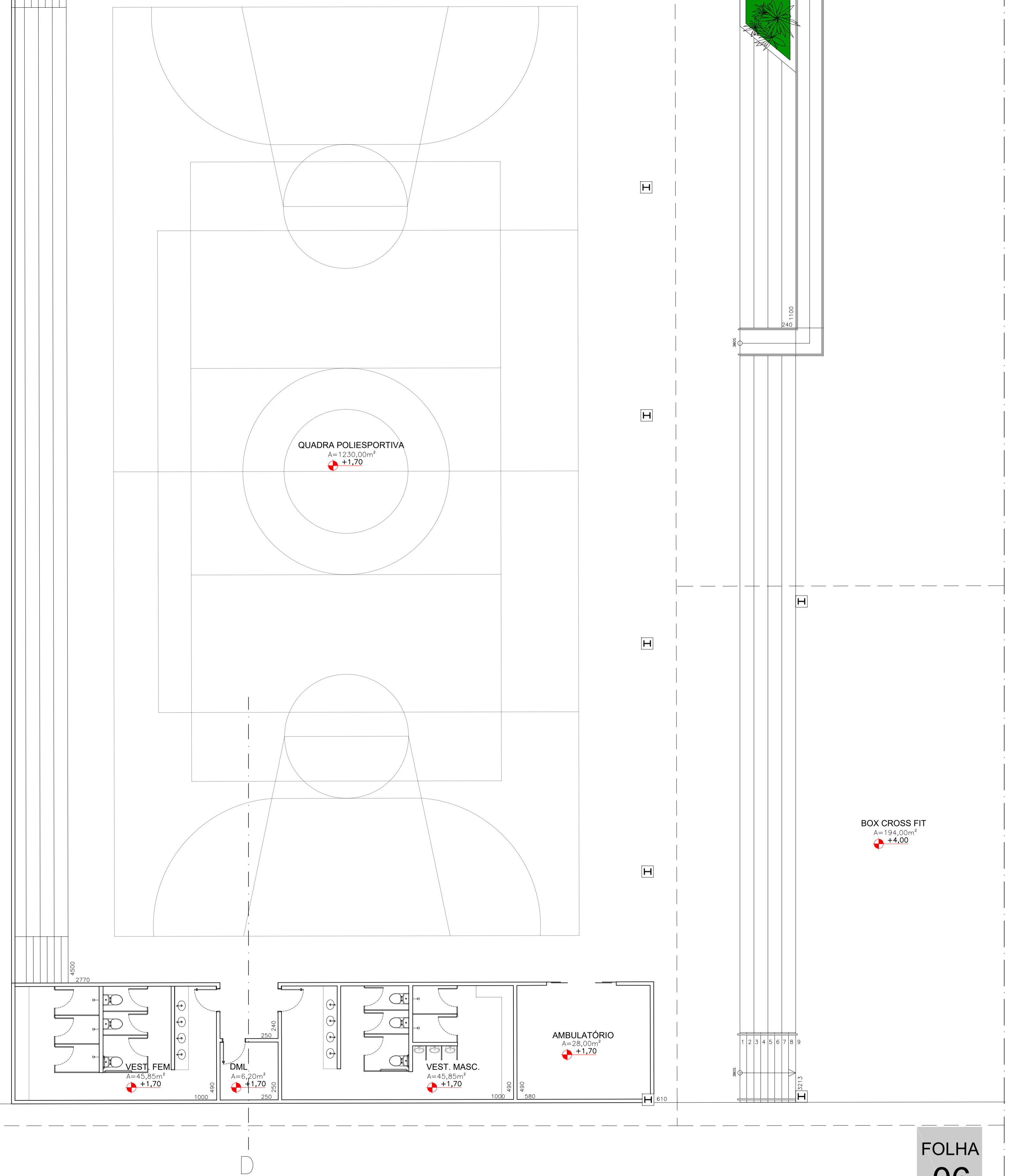

BOX CROSS FIT
A=194,00m²
+4,00

QUADRA POLIESPORTIVA
A=1230,00m²
+1,70

VESTI. FEM.
A=45,85m²
+1,70

DML
A=6,20m²
+1,70

VEST. MASC.
A=45,85m²
+1,70

AMBULATÓRIO
A=28,00m²
+1,70

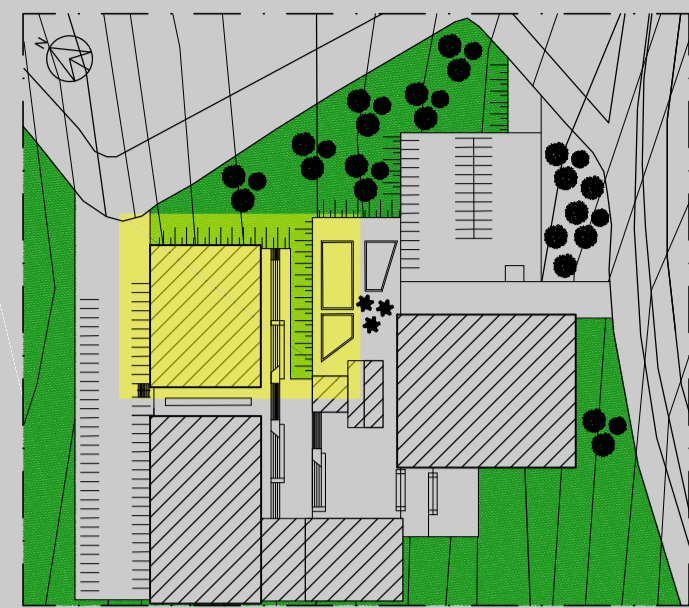

PLANTA CHAVE
ESCALA 1:1000

ESTACIONAMENTO
A=2190,00m²
+0,00

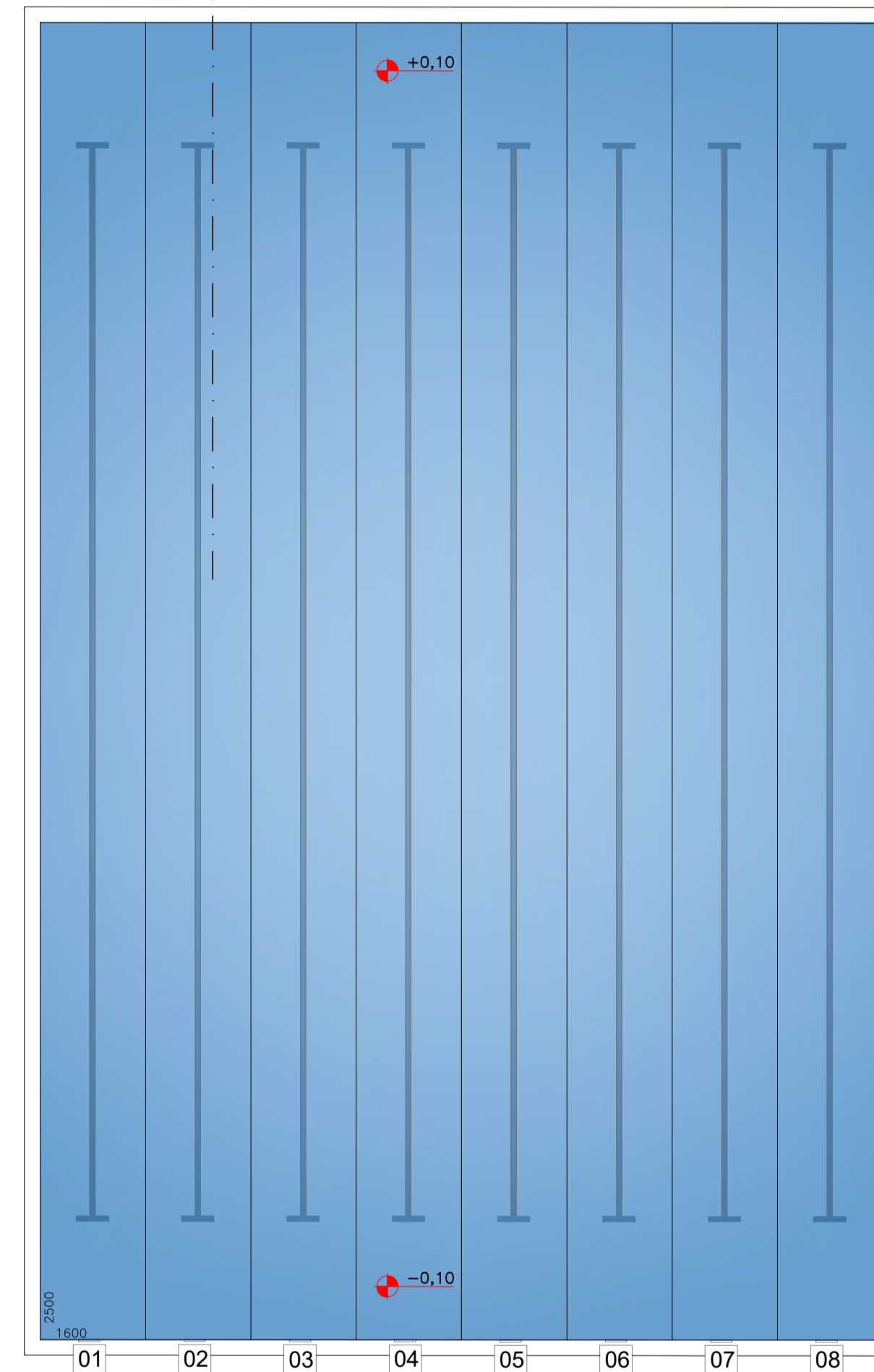
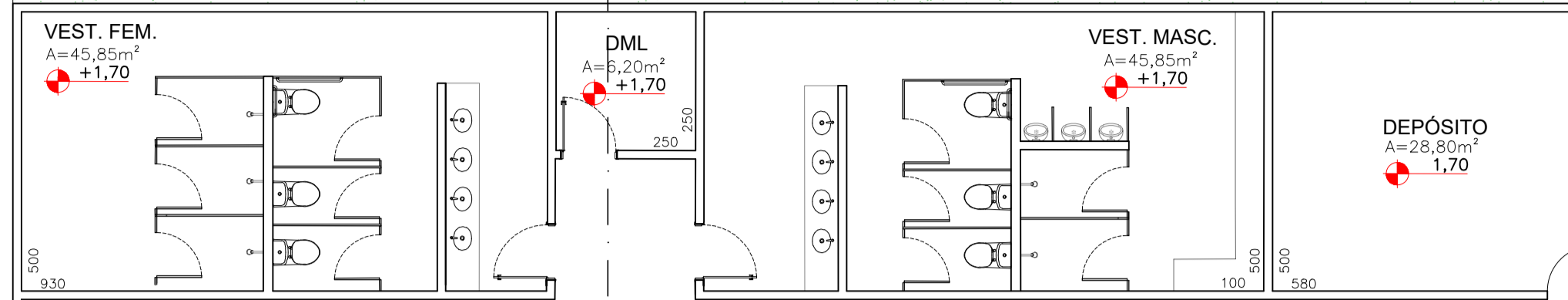
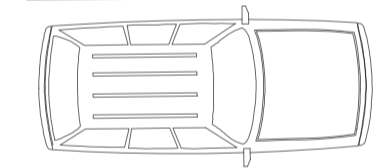
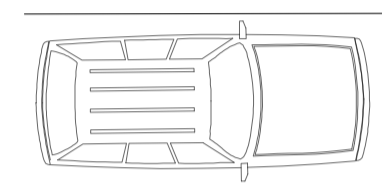

CIRCULAÇÃO
+1,70

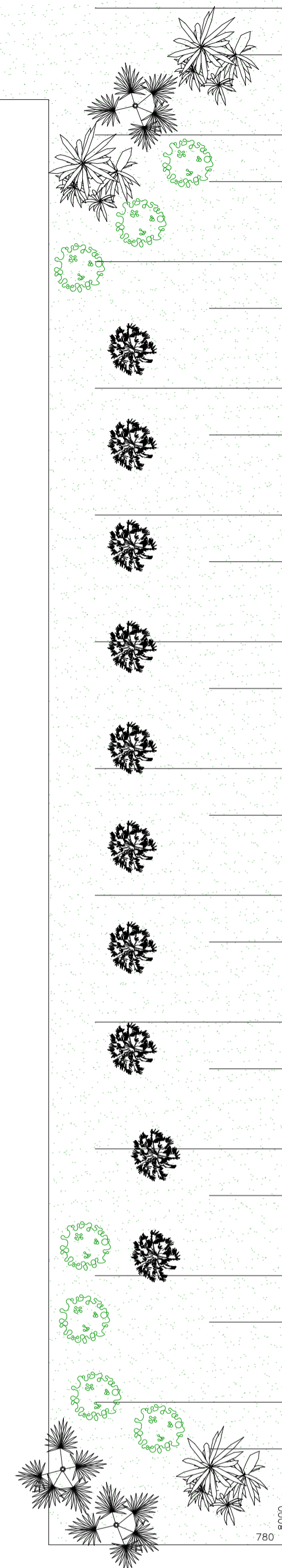
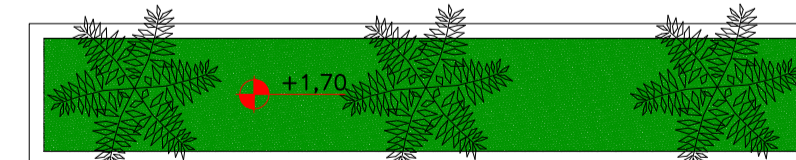
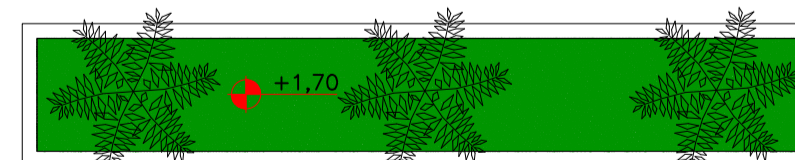



PLANTA CHAVE
ESCALA 1:1000



PERSPECTIVA
PISCINAS

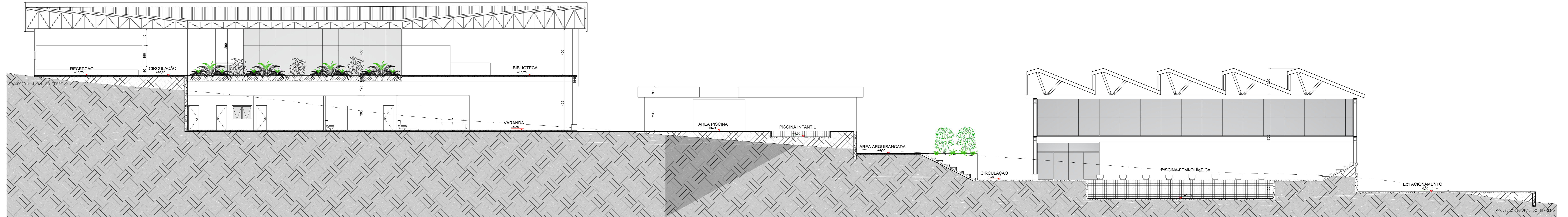

CORTE A.A

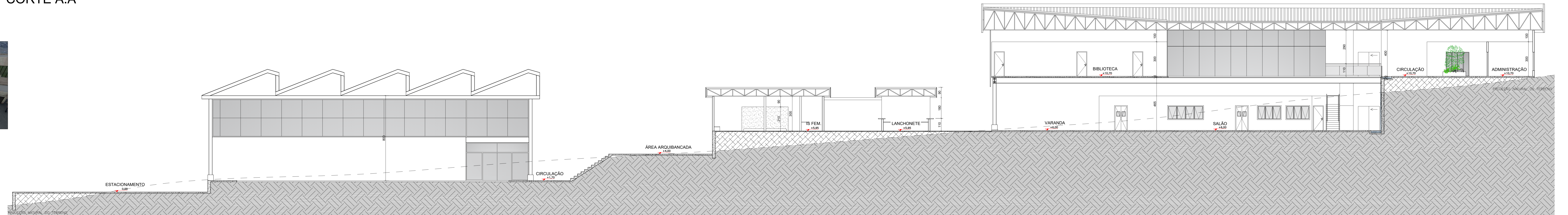

CORTE B.B

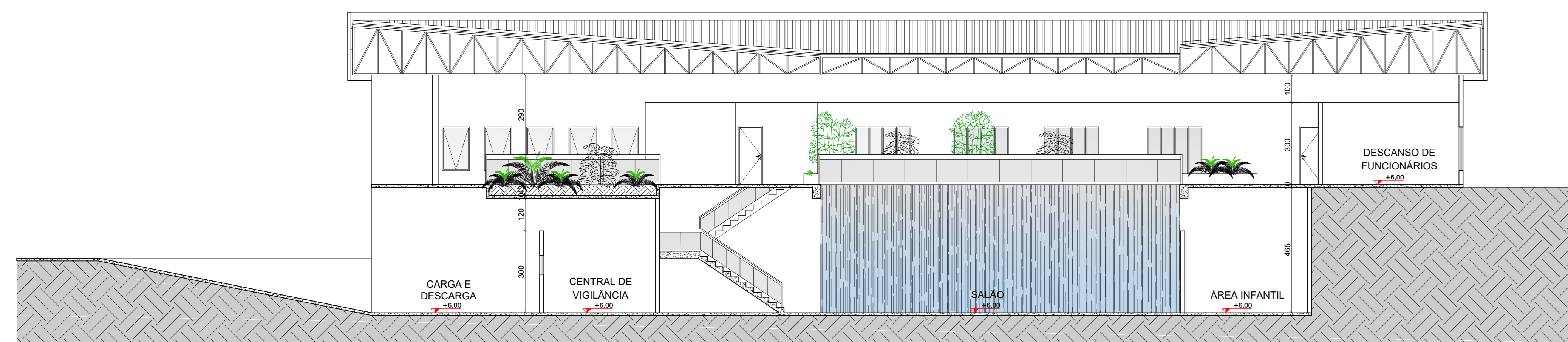

CORTE C.C

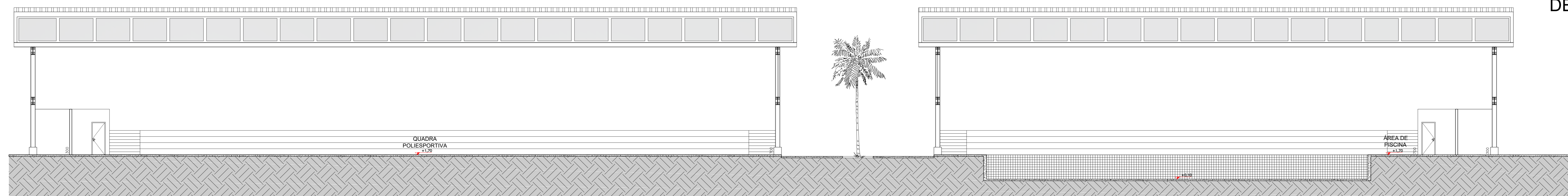

CORTE D.D

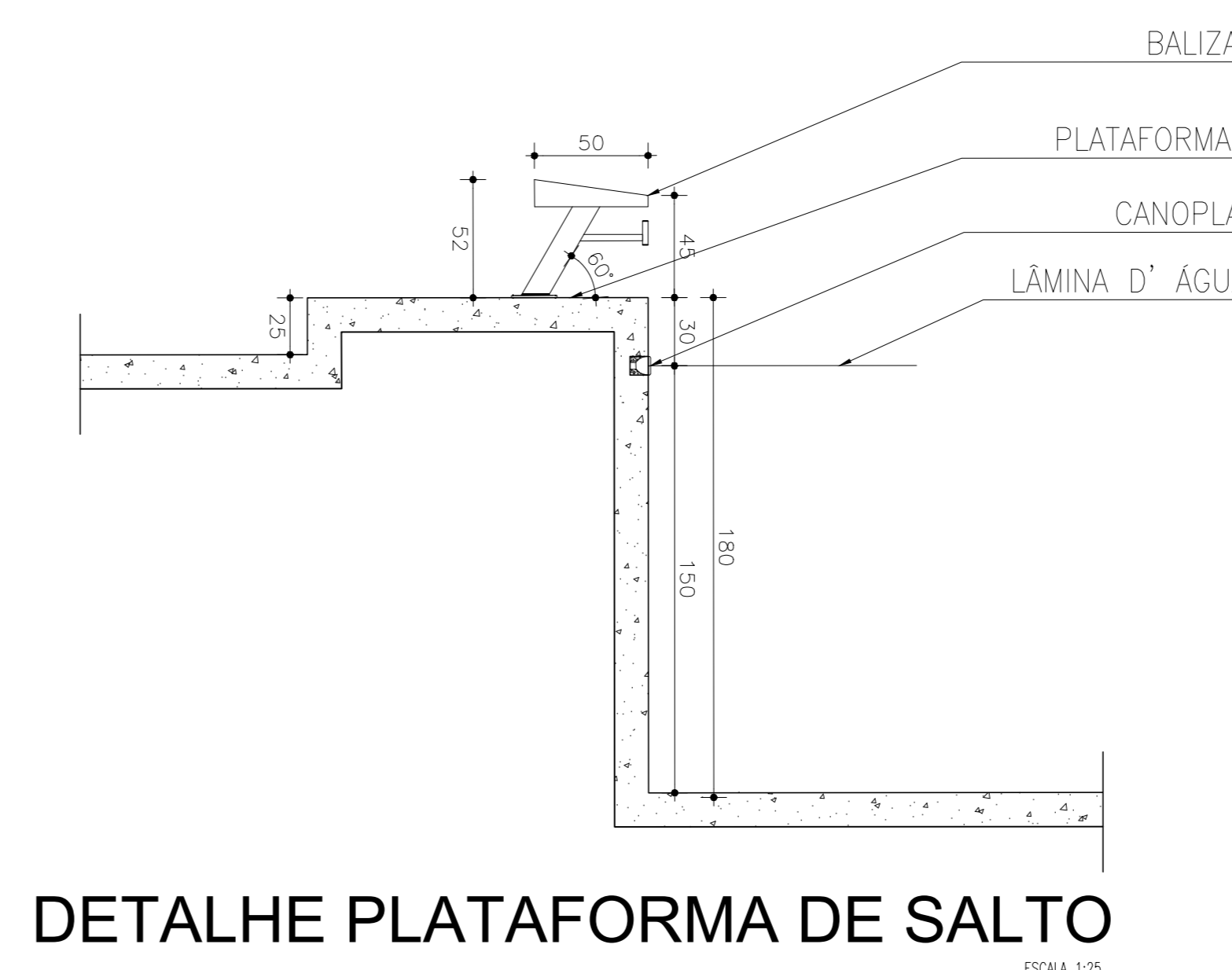

DETALHE PLATAFORMA DE SALTO

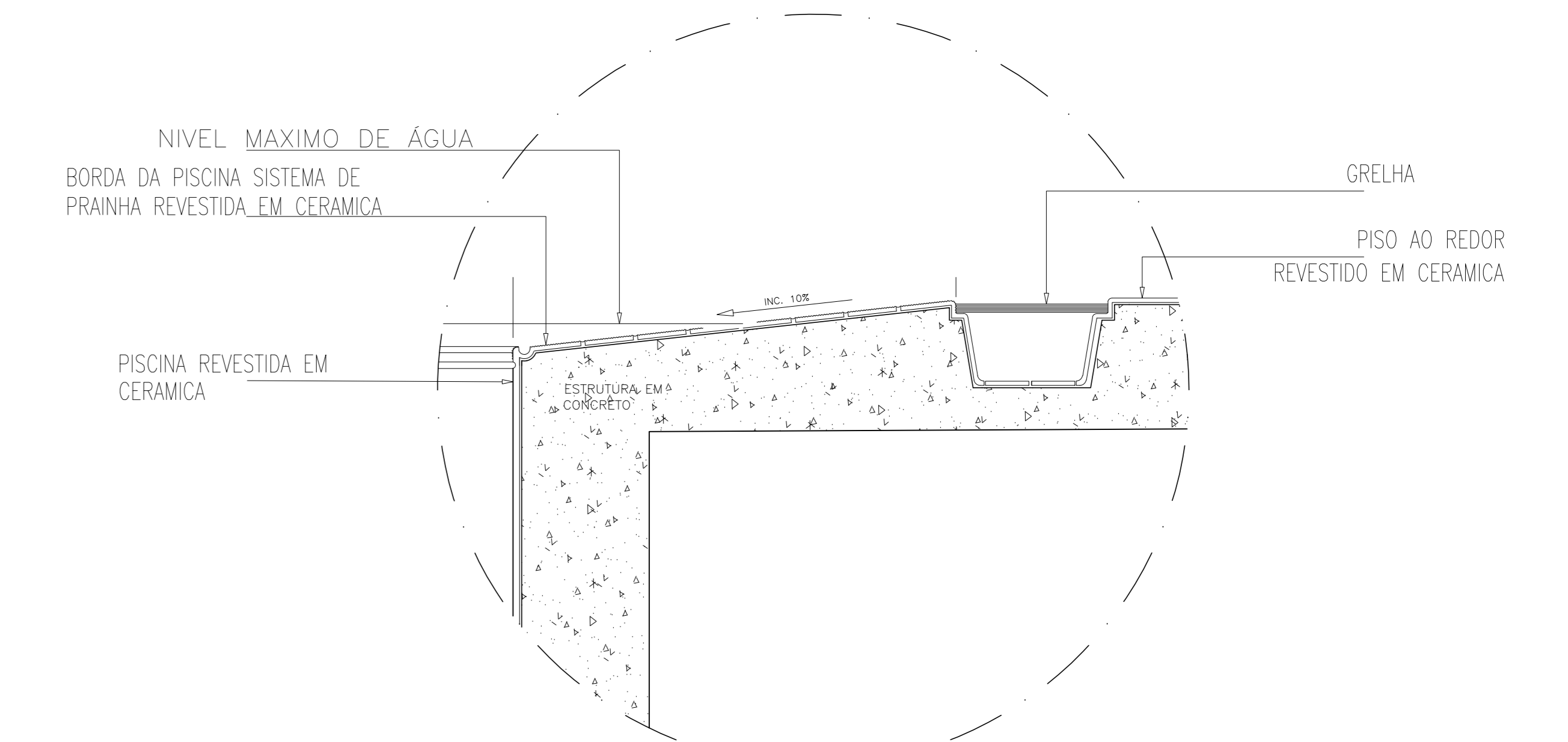

DETALHE DE BORDA

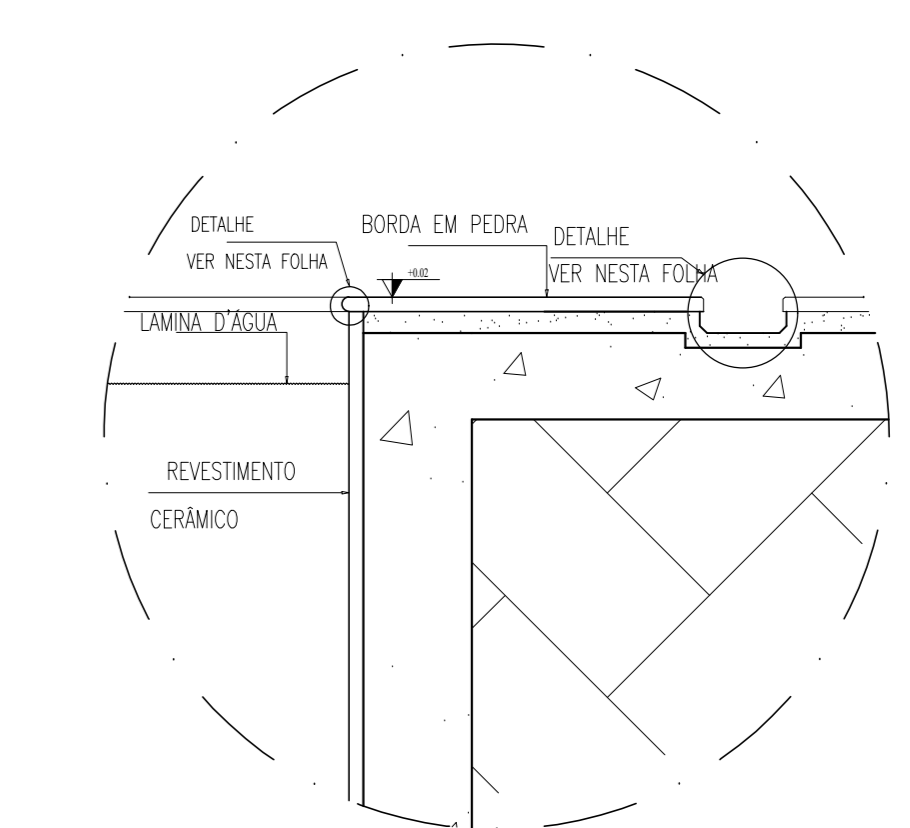

DETALHE-BORDA
DA PISCINA

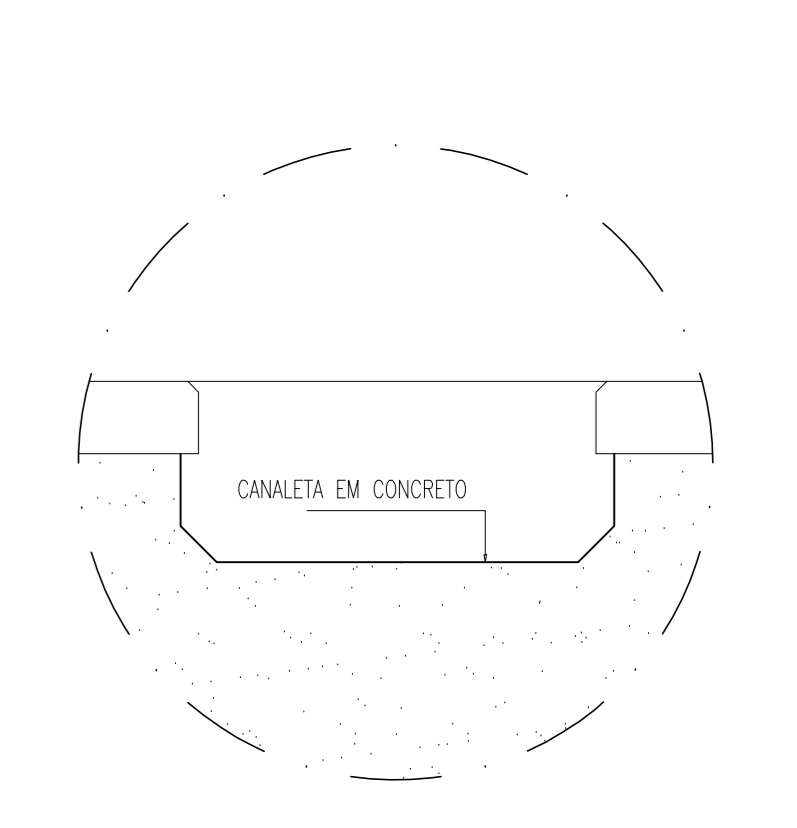

DETALHE
CANALETA

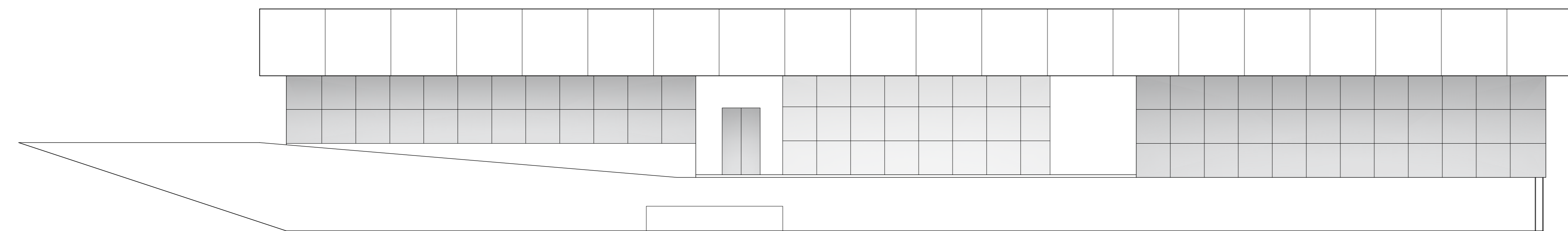

FACHADA LESTE

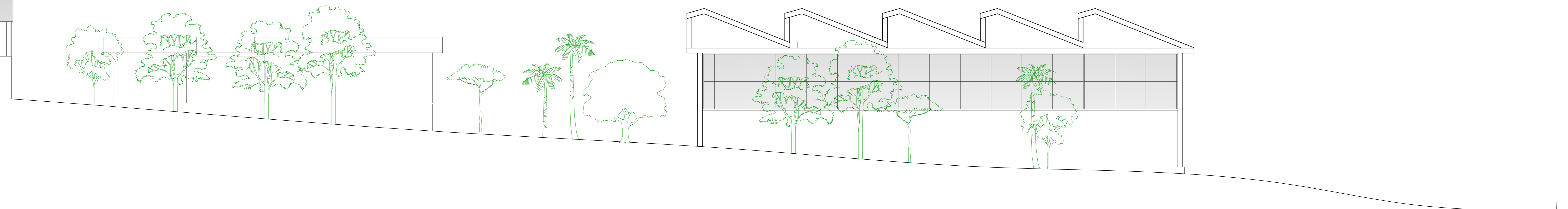

FACHADA SUL

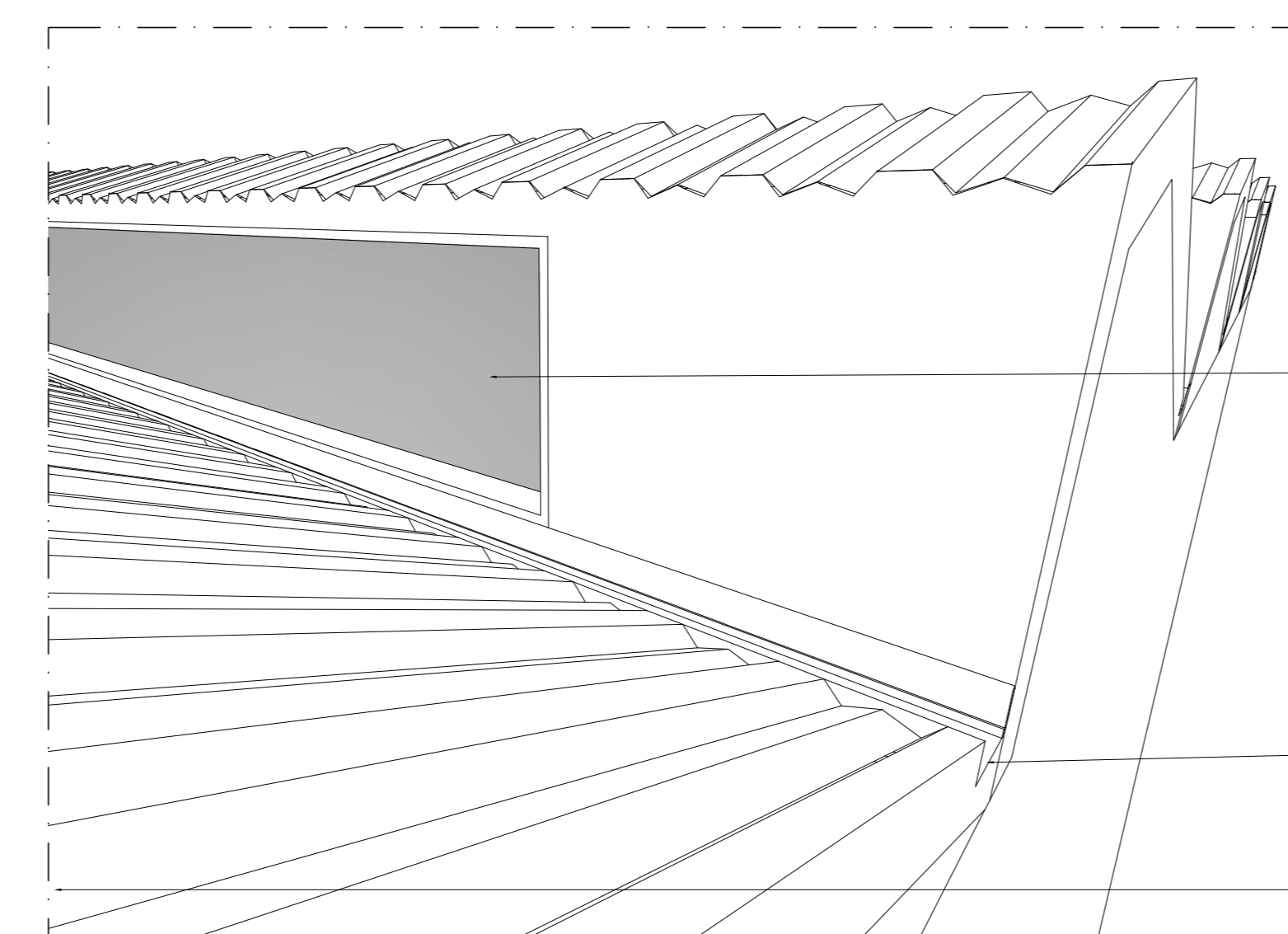
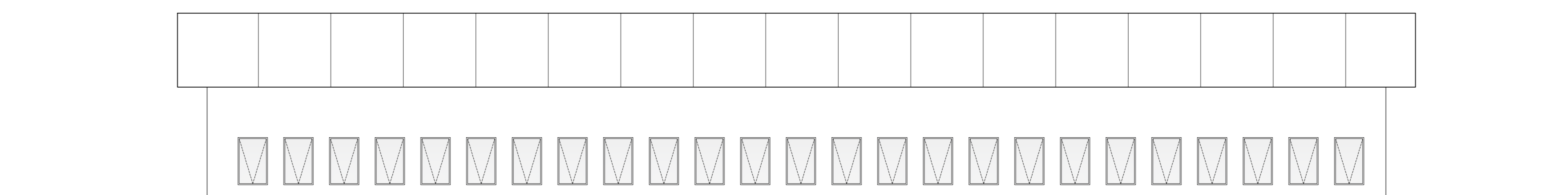

DETALHE SHEDS

ABERTURA COM FECHAMENTO EM VIDRO
CALHA
TELHA TIPO SANDUICHE, VER INCLINAÇÃO NA PLANTA DE COBERTURA

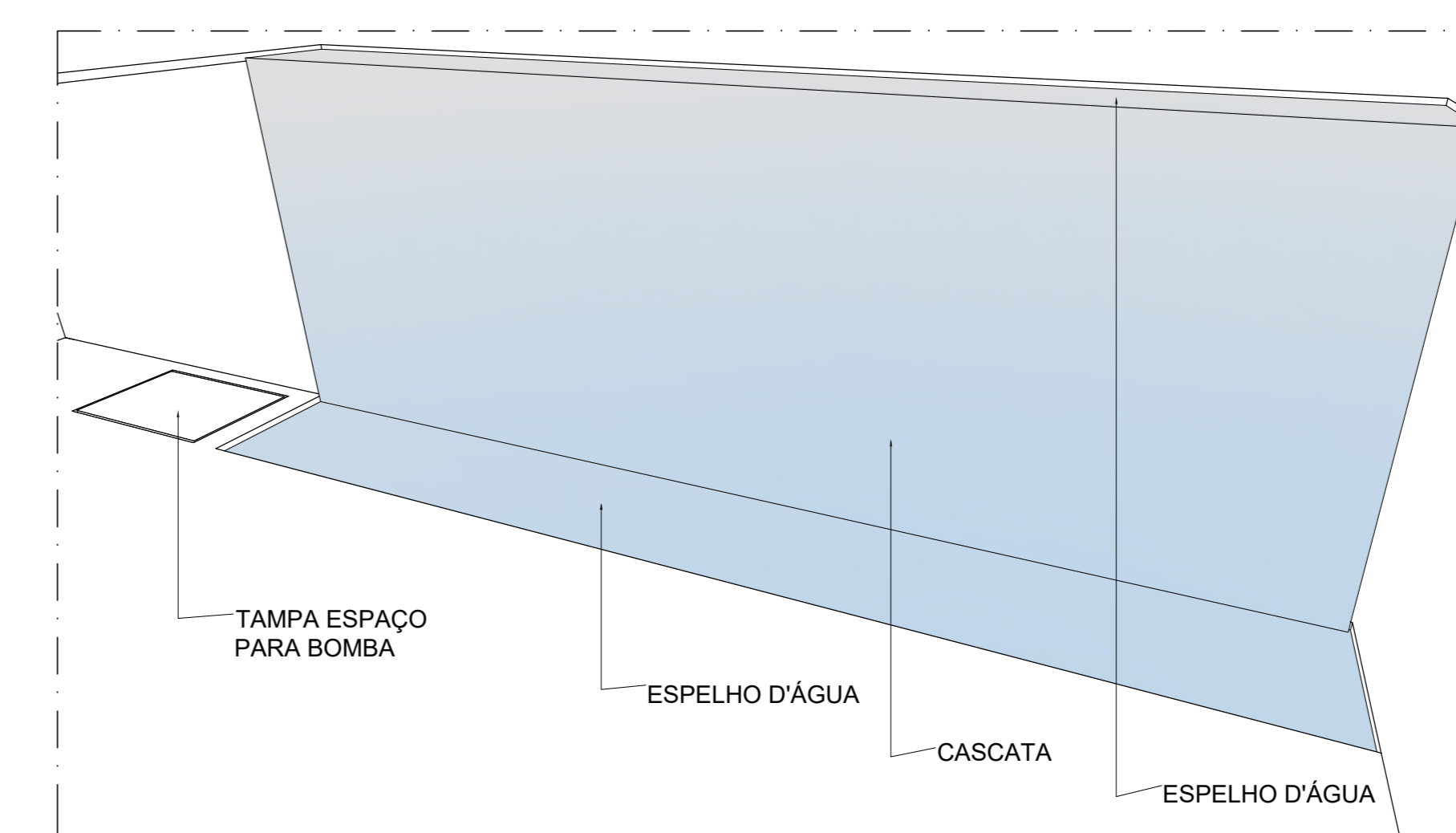

PERSPECTIVA CASCATA

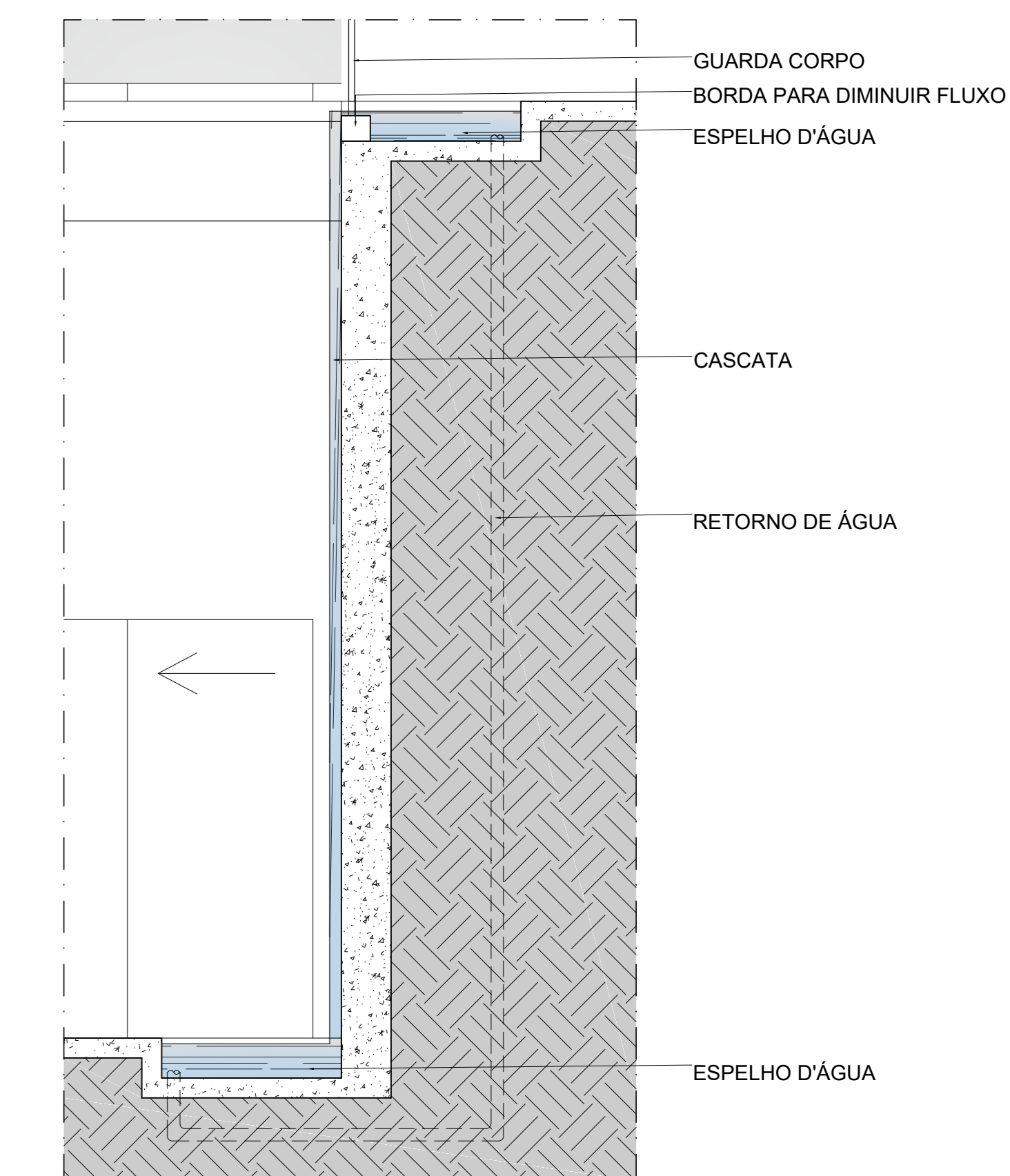

DETALHE CASCATA
ESCALA 1:25



PLANTA CHAVE
ESCALA 1:1000

